

# IONNIC LED Worklamps

- Compact design.
- Powerful 5W LEDs.
- Stainless steel mounting bracket.
- Impact resistant lens.
- Robust cast alloy body.
- Environmentally sealed – IP67, IP6K9K.
- TE DEUTSCH compatible connector encapsulated in body.
- Low current draw.
- Multi-voltage.
- 3-year warranty.



8210 LED

Lumen Output :	1,500lm
Operational Voltage :	9–32V
Current Draw :	0.7A @ 13.8V
Connector :	DT Style – 2 Pin
Mount :	Single Bolt M8
Lens :	Polycarbonate
Body :	Aluminium
Bracket :	Stainless Steel
Weight :	0.6kg
Approvals :	E-mark
Ingress Protection :	IP67, IP6K9K
Operating Temperature :	-40°C to 85°C
Colour Temperature :	5500K
Light Source :	4 x Osram 5 Watt LEDs

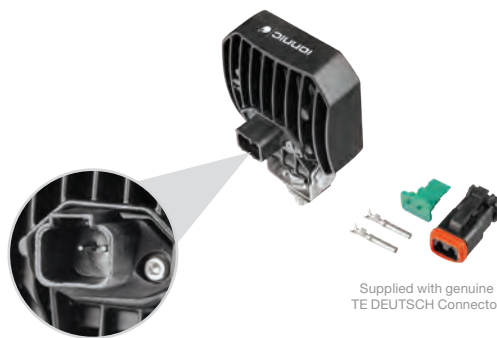
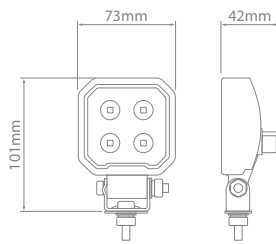

## 8210 LED – Flood

Part No.	Operational Voltage
<b>98-8210</b>	<b>9–32</b>

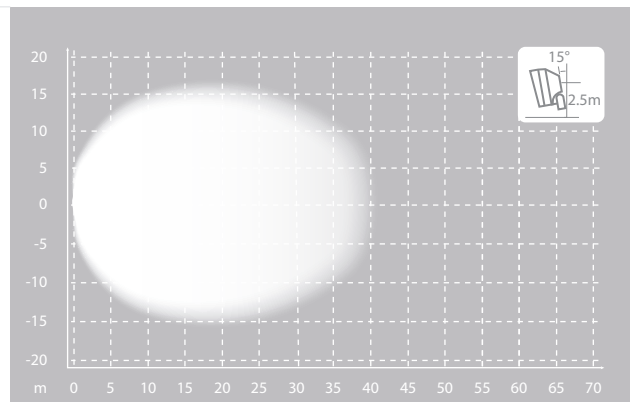

# IONNIC LED Worklamps

8220 LED



- Powerful 5W LEDs.
- Stainless steel mounting bracket.
- Impact resistant lens.
- Robust cast alloy body.
- Environmentally sealed – IP67, IP6K9K.
- TE DEUTSCH compatible connector encapsulated in body.
- Low current draw.
- Multi-voltage.
- 3-year warranty.

12V 32V IP67 IP69K 3Yrs

Lumen Output :	2,350lm
Operational Voltage :	9–32V
Current Draw :	1.2A @ 13.8V
Connector :	DT Style – 2 Pin
Mount :	Single Bolt M10
Lens :	Polycarbonate
Body :	Aluminium
Bracket :	Stainless Steel
Weight :	0.8kg
Approvals :	E-mark
Ingress Protection :	IP67, IP6K9K
Operating Temperature :	-40°C to 85°C
Colour Temperature :	5500K
Light Source :	6 x Osram 5 Watt LEDs



Supplied with genuine TE DEUTSCH Connector

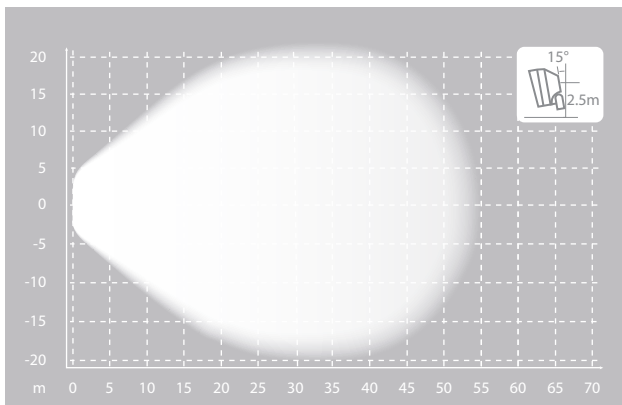
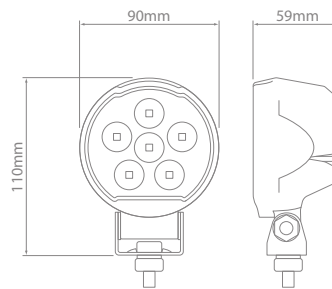

## 8220 LED – Flood

Part No. **98-8220** Operational Voltage **9–32**

# IONNIC LED Worklamps

- Powerful 5W LEDs.
- Stainless steel mounting bracket.
- Impact resistant lens.
- Robust cast alloy body.
- Environmentally sealed – IP67, IP6K9K.
- TE DEUTSCH compatible connector encapsulated in body.
- Multi-voltage.
- 3-year warranty.

Lumen Output :	3,500lm
Operational Voltage :	9–32V
Current Draw :	2.0A @ 13.8V
Connector :	DT Style – 2 Pin
Mount :	Single Bolt M10
Lens :	Polycarbonate
Body :	Aluminium
Bracket :	Stainless Steel
Weight :	1.0kg
Approvals :	E-mark
Ingress Protection :	IP67, IP6K9K
Operating Temperature :	-40°C to 85°C
Colour Temperature :	5500K
Light Source :	9 x Osram 5 Watt LEDs



8230 LED

12V 32V IP67 IP69K 3Yrs

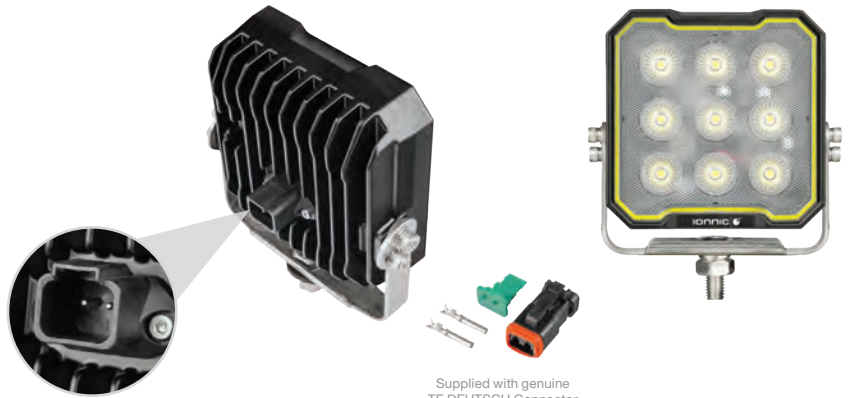
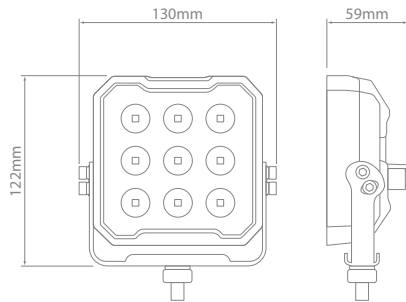

Supplied with genuine TE DEUTSCH Connector

## 8230 LED – Flood

Part No.	Operational Voltage
<b>98-8230</b>	<b>9–32</b>

